

TSE100

MONITOR & KEYBOARD
E X T E N D E R

USER MANUAL

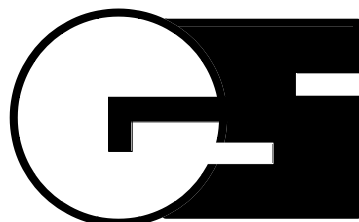

GEFEN SYSTEMS

Gefen, Inc.

20600 Nordhoff Street, Chatsworth CA 91311

1-800-545-6900 818-772-9100

TSE100

MONITOR & KEYBOARD
E X T E N D E R

Monitor

Keyboard

Mouse

Trackball

Touchscreen

ASKING FOR ASSISTANCE

Technical Support:

Telephone (818) 772-9100
(800) 545-6900

Fax (818) 772-9120

Technical Support Hours:

8:00 AM to 5:00 PM Monday thru Friday.

Gefen, Inc.
c/o Customer Service
20600 Nordhoff Street
Chatsworth CA 91311

www.gefen.com -- support@gefen.com

Notice

Gefen reserves the right to make changes in the hardware, packaging and any accompanying documentation without prior written notice.

TSE100 is a trademark of Gefen, Inc.

Macintosh is a trade mark of Apple Computer Inc.

TABLE OF CONTENTS

General Information

Introduction	1
Operation Notes	2
TSE100S Panel Sender Layout	3
TSE100S Function Description	4
TSE100R Reciever Panel Layout	5
TSE100R Function Description	6
Dip Switch Settings	11
Warranty	13

Installation Wiring Diagrams

2 Monitors Local/Extended	7
1 Monitor Extended	8
2 Monitors Extended	9
TSE100 Link Cable	10

INTRODUCTION

Thank you for purchasing Gefen Systems' TSE100 Series. The TSE100 extends your computer monitor, keyboard, mouse, trackball, and touch screen device up to 500 feet away from the location of your Macintosh computer.

The TSE100 system consists of two units, the TSE100S Sender which resides next to the computer side and the TSE100R Receiver, which resides next to the extended monitor and keyboard.

The monitor port on your computer is typically divided into three color outputs, Red, Green, Blue (RGB) and three Sync signals. The TSE100S buffers the (RGB) signal. These signals are extended by BNC connectors.

The ADB signal controls the keyboard, mouse, trackball and other ADB devices such as a touch screen. The TSE100S buffers the ADB signal through send and receive line drivers, and the signal is extended by using standard telephone cable.

You can connect additional TSE100 Series to the same computer, allowing you to access the computer from other locations up to 500 feet apart.

OPERATION NOTES

READ THESE NOTES BEFORE INSTALLING OR OPERATING THE TSE100 SYSTEM.

1. **WARNING!** The TSE100 were designed to operate on Macintosh computers. Do not attempt to use this equipment with any other type computers.
2. The TSE100S is shipped with monitor switch setting for 640X480 resolution. For details on how to change the default setting, refer to page 11.
3. **WARNING!** When using a local keyboard **not extended** with the TSE100S unit, use the Gefen modified ADB cable. Modified cable is connected between the TSE100S **sender** and the local keyboard or mouse.
3. **WARNING!** When plugging in a TSE100 Sender unit **ONLY**, without the TSE100 receiver unit, the keyboard and mouse will freeze. The TSE100 Receiver unit must be connected, and powered up, and the link cable installed between both units, in order to operate property.
4. When using the TSE100 with two monitors, one extended and one local, both monitors **MUST** be the same type. If the monitors are different, they will not initialize correctly.
5. Link Cable: Refer to the wiring diagram on page 10 for wiring instructions.

TSE100S SENDER PANELS LAYOUT

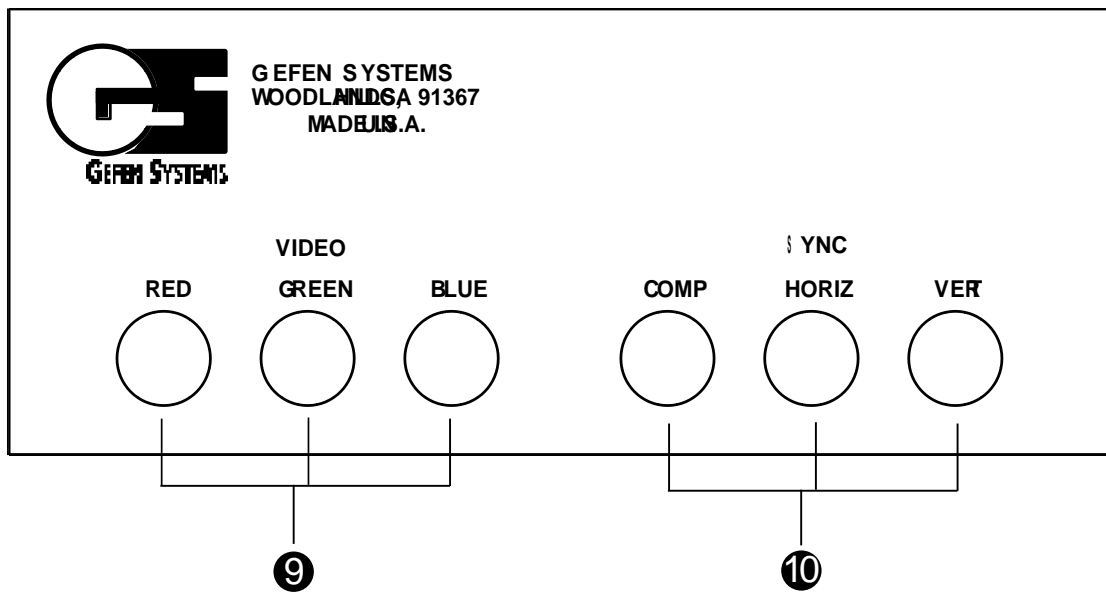
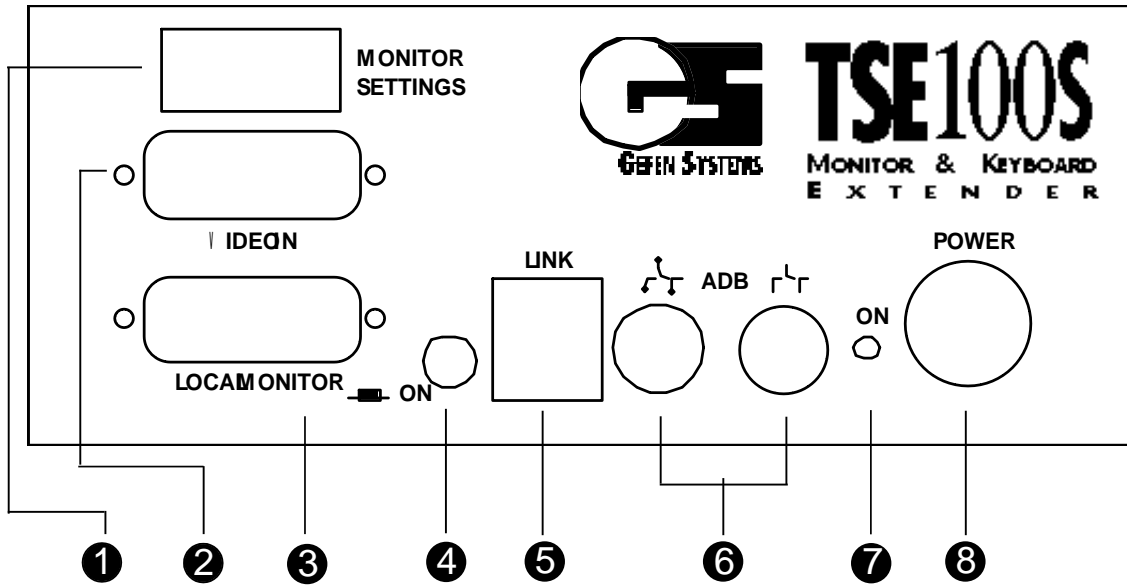

FUNCTION DESCRIPTION

- ① **Monitor Setting**
Monitor size and screen resolution switch setting.
- ② **Computer / Video In**
DB-15 Male Connector which connects to the computer monitor port.
- ③ **Local Monitor In**
DB-15 female connector which connects the local monitor.
- ④ **Terminator Switch**
Terminate the video Input if local monitor is not used.
- ⑤ **Link**
RJ-11 Modular Jack which connects to the TSE100R (Receiver Unit).
- ⑥ **ADB**
Mini din sub connector which connects to the computer ADB port. (For keyboard, Mouse and Trackball).
- ⑦ **Power On Light**
Power on status indicates that the unit is plugged in.
- ⑧ **Power**
17 Volt center tap A/C 700ma external power supply.
- ⑨ **Video Outputs**
RGB video output signal using BNC connectors.
- ⑩ **Sync Outputs**
Composite, Horizontal, Vertical sync output signal using BNC connectors.

TSE100R RECEIVER PANELS LAYOUT

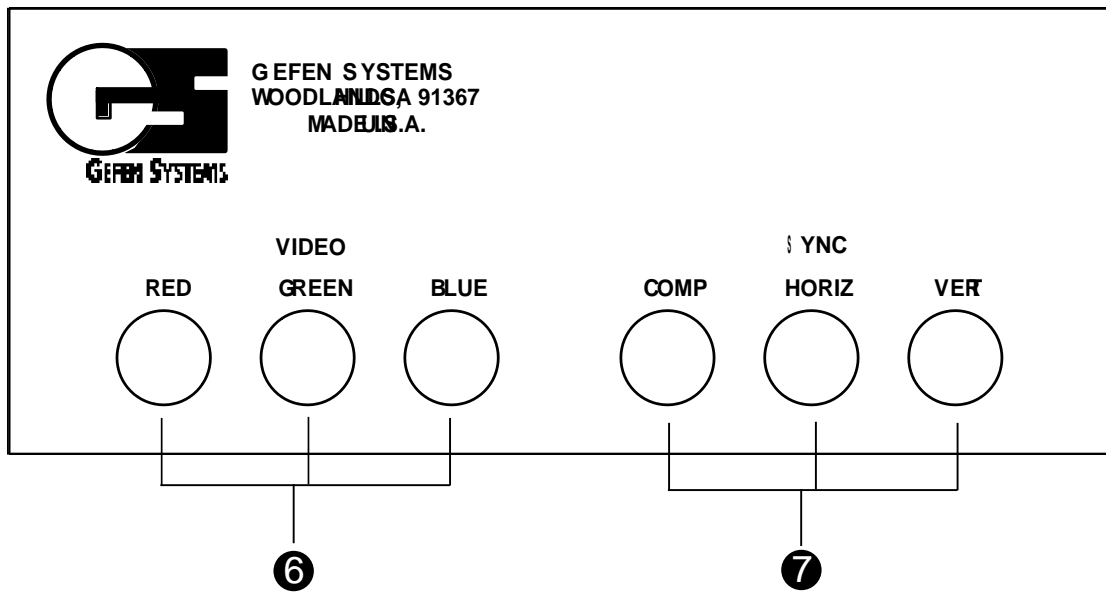
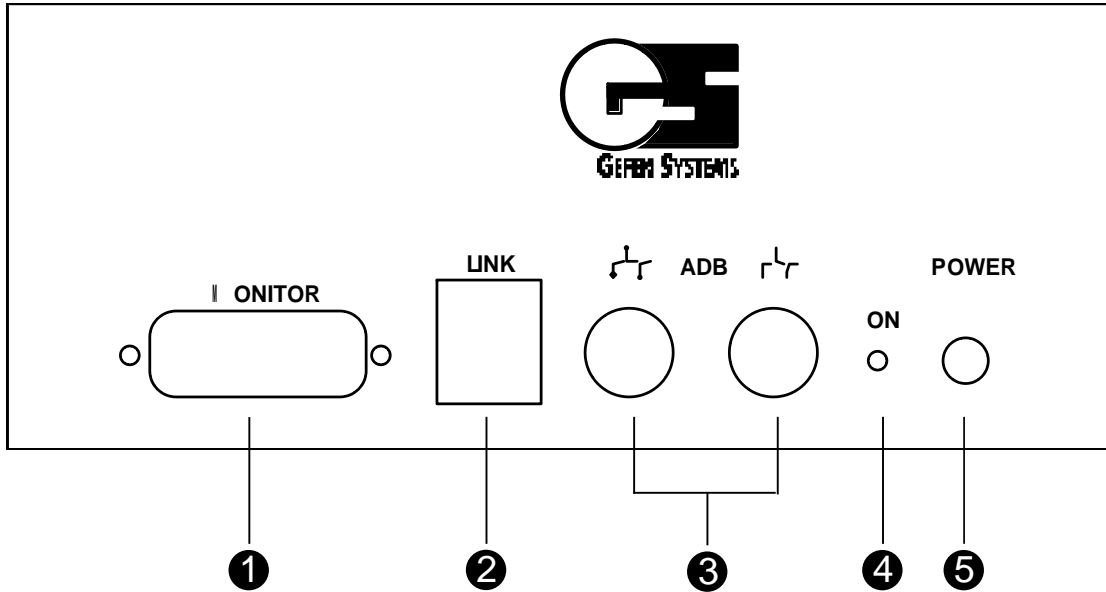

FUNCTION DESCRIPTION

- ① **Monitor**
DB-15 female connector which connects the extended monitor.

- ② **Link**
RJ-11 modular Jack which connects to a TSE100S (Sender Unit).

- ③ **ADB**
Mini din sub connector which connects the extended ADB port. (For keyboard, Mouse and Trackball).

- ④ **Power On Light**
Power on status indicates that the unit is plugged in.

- ⑤ **Power**
9 Volt A/C 1A external power supply.

- ⑥ **Video In (BNC)**
RGB video input signal using BNC connectors.

- ⑦ **Sync In (BNC)**
Composite, Horizontal, Vertical sync input signal using BNC connectors.

2 MONITORS LOCAL/EXTENDED - WIRING DIAGRAM

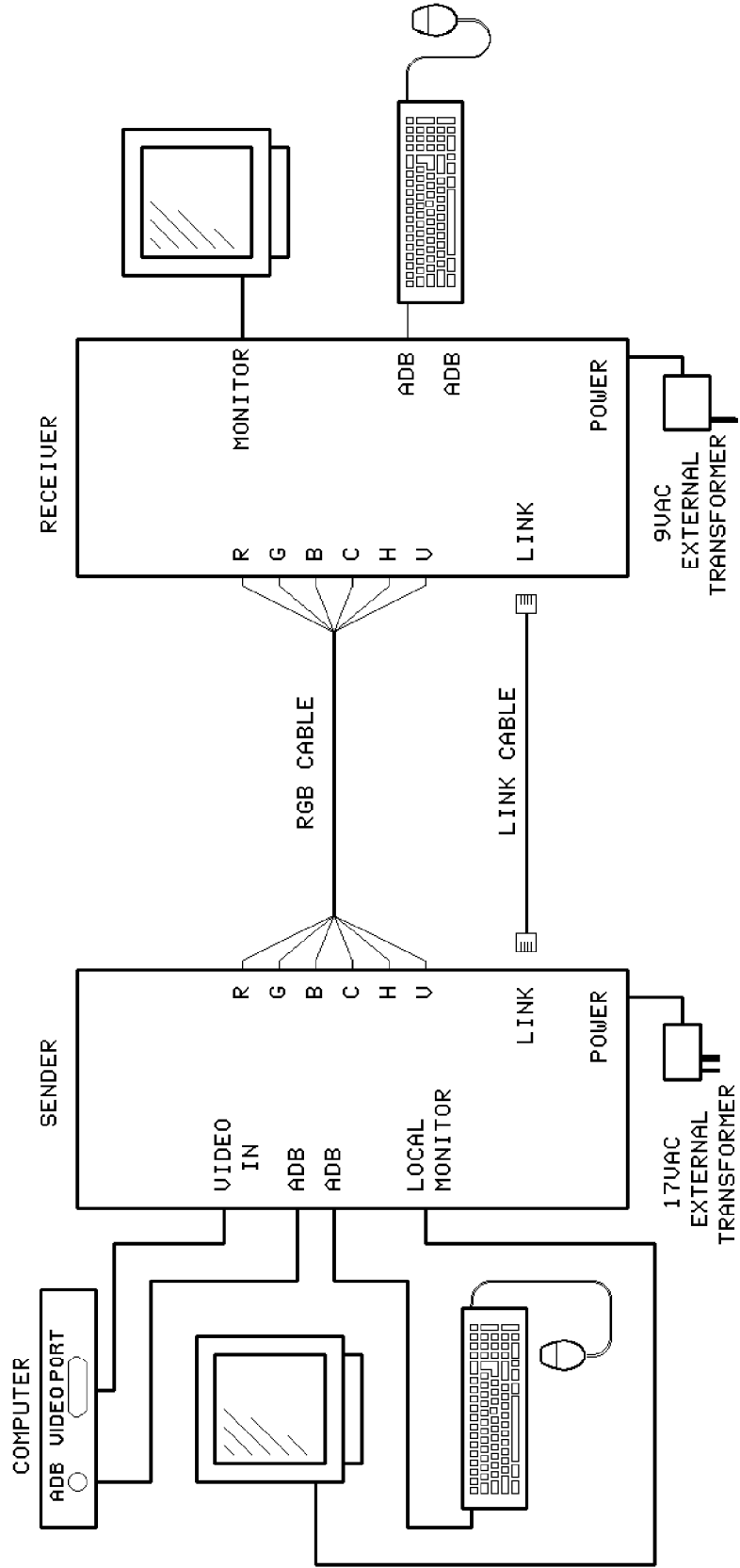

1 MONITOR EXTENDED - WIRING DIAGRAM

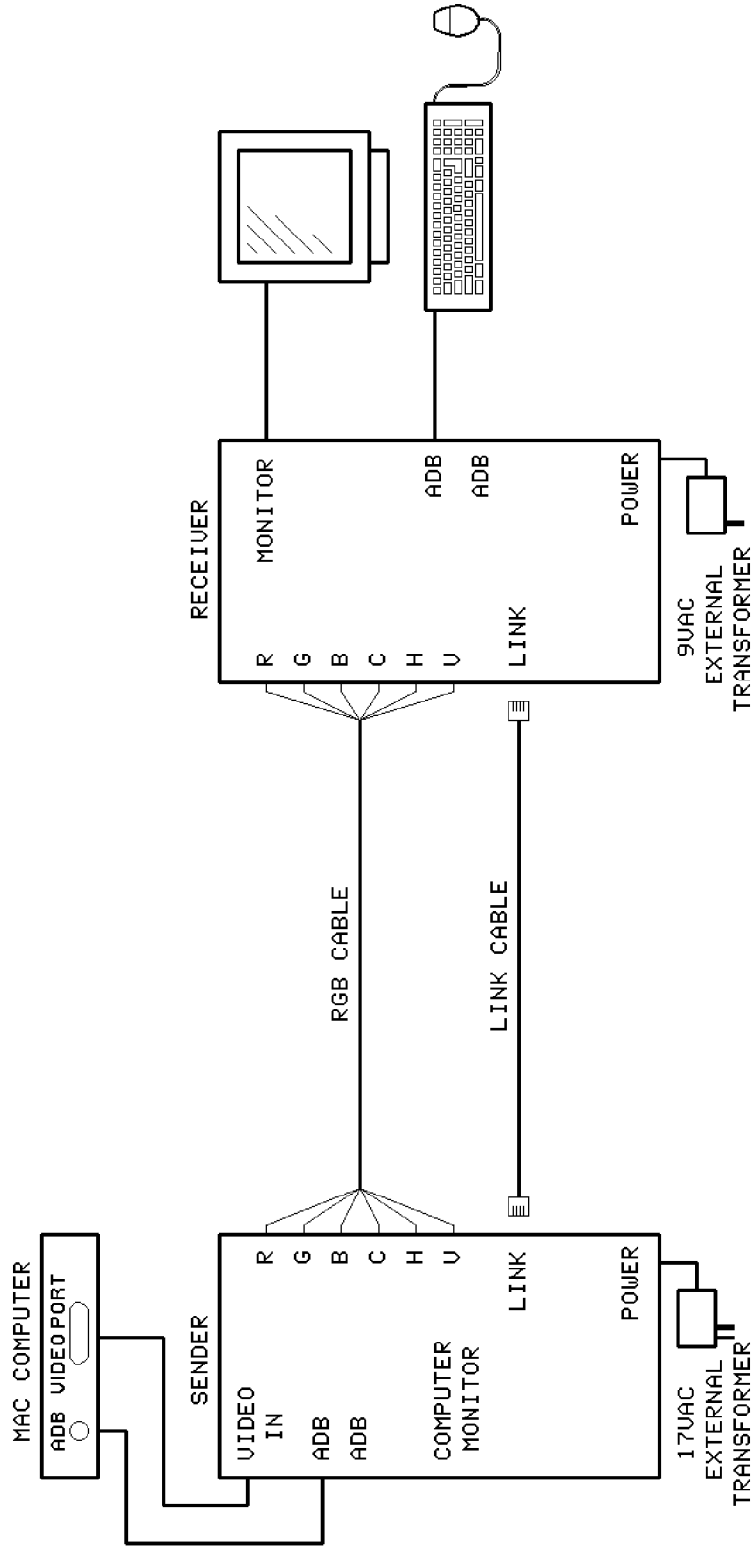

2 MONITORS EXTENDED - WIRING DIAGRAM

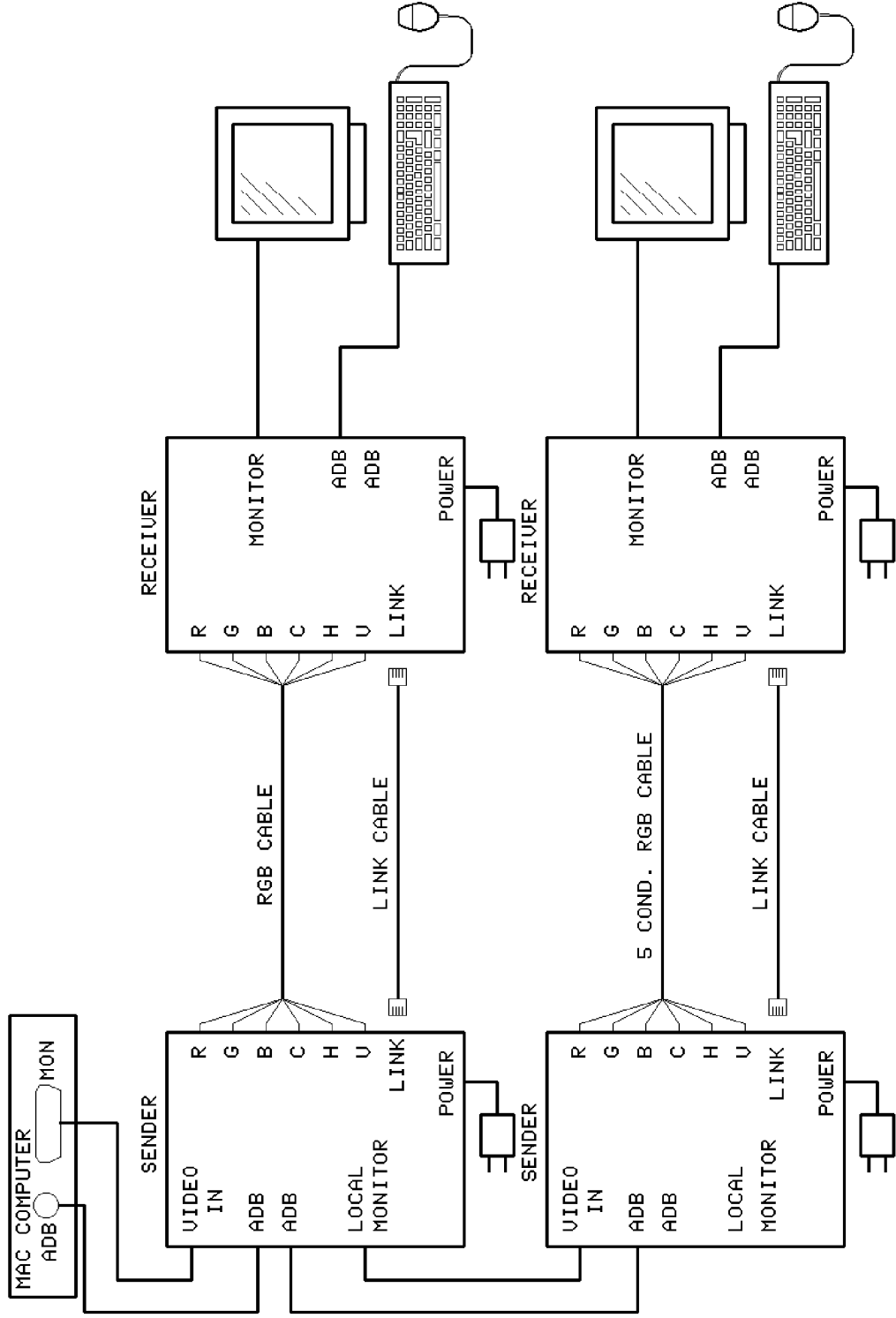

TSE100 LINK CABLE - WIRING DIAGRAM

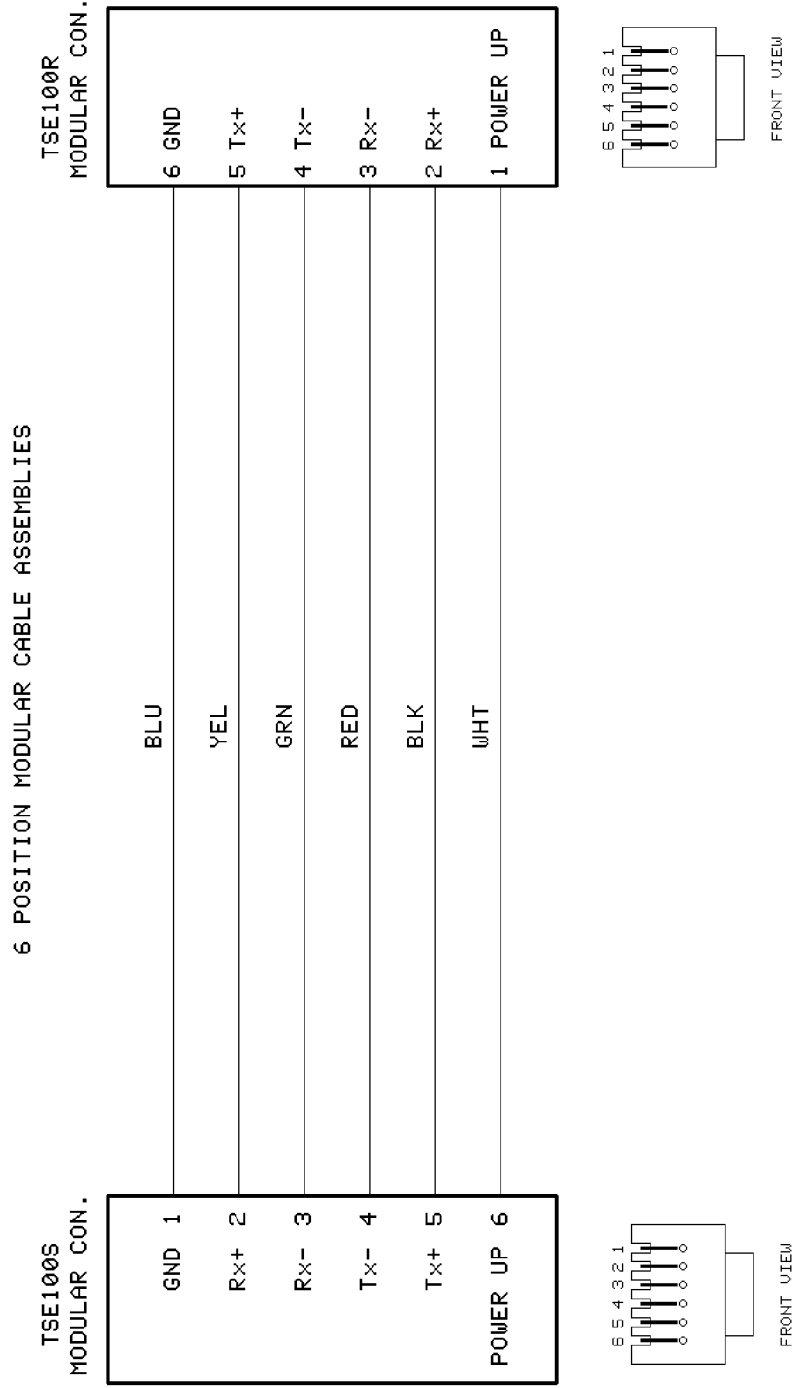

MONITOR DIP SWITCH SETTINGS

Note: The following configurations can be used for setting up the most common monitor sizes. If you can't find your specific monitor setting, Call or fax Gefen Systems for assistance. The dip switches are located on the front Panel of the TSE100S unit.

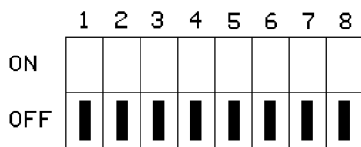

1. ALL OFF

Use this setting when extended and local monitor are connected.

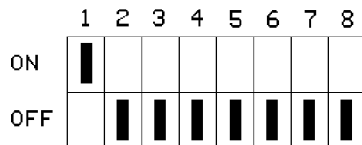

2. Dip Switch 1 ON

Use for 14" Monitors.
Standard 640X480 Resolution.
Use Composite Sync only.

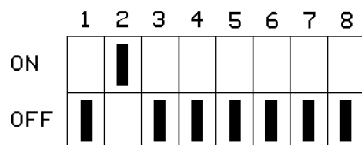

3. Dip Switch 2 ON

Use for VGA / Super VGA Monitors.
Use Horiz. and Vert. Sync. only.

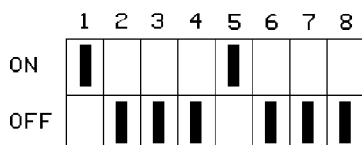

3. Dip Switch 1 & 5 ON

Use for MultiScan 17" Monitors.
Use Horiz. and Vert. Sync. only.

MONITOR DIP SWITCH SETTINGS

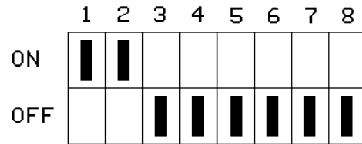

- 4. Dip Switches 1 & 2 ON**
Use for MultiScan 14" Monitors.
Use Horiz. and Vert. Sync. only.

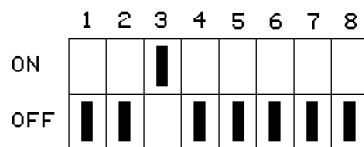

- 5. Dip Switch 3 ON**
Use for RGB 17" Monitor.
Use Horiz. and Vert. Sync. only.

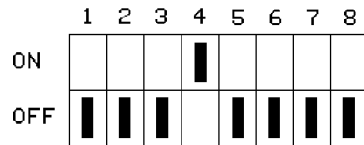

- 6. Dip Switch 4 ON**
Use for RGB 19" Monitors.
Use Horiz. and Vert. Sync. only.

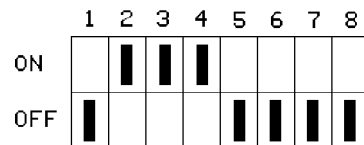

- 7. Dip Switch 2,3 & 4 ON**
Use for PAL Monitors.
Use Horiz. and Vert. Sync. only.

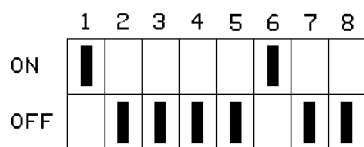

- 8. Dip Switch 1 & 6 ON**
Use for MultiScan 21" Monitors.
Use Horiz. and Vert. Sync. only.

WARRANTY

Gefen Systems warrants the equipment it manufactures to be free from defects in material and workmanship.

If equipment fails because of such defects and Gefen Systems is notified within one (1) year from the date of shipment, Gefen System will, at its option, repair or replace the equipment, provided that the equipment has not been subjected to mechanical, electrical, or other abuse or modifications.

Equipment that fails under conditions other than those covered will be repaired at the current price of parts and labor in effect at the of repair. Such repairs are warranted for ninety (90) days from the day of reshipment to the Buyer.

This warranty is in lieu of all other warranties expressed or implied, including without limitation, any implied warranty or merchantability or fitness for any particular purpose, all of which are expressly disclaimed.

The information in this manual has been carefully checked and is believed to be accurate. However, Gefen Systems assumes no responsibility for any inaccuracies that may be contained in this manual. In no event will Gefen Systems, be liable for direct, indirect, special, incidental, or consequential damages resulting from any defect or omission in this manual, even if advised of the possibility of such damages. The technical information contained herein regarding TSE100 features and specifications is subject to change without notice.

All Rights Reserved © Copyright 1995 Gefen Systems

This document was created with Win2PDF available at <http://www.daneprairie.com>.
The unregistered version of Win2PDF is for evaluation or non-commercial use only.